

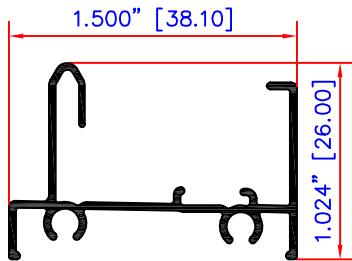

Línea Euroalum[®] 1500

*Elegancia, distinción y
funcionalidad a su servicio.*



JAMBA RIEL Y CABEZAL
1517

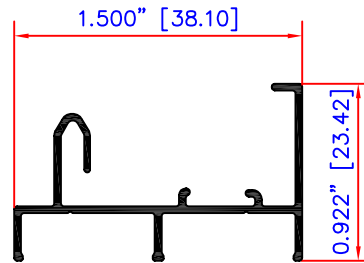

JAMBA LATERAL
1516

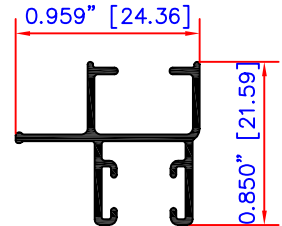

CERCO JALADERA HOJA
1524

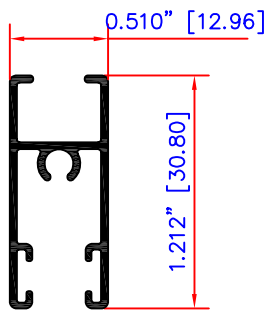

CABEZAL
1521

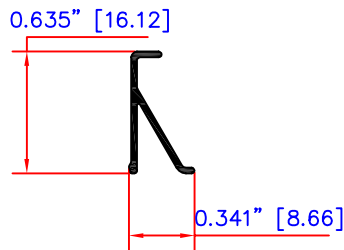

JUNQUILLO
1522

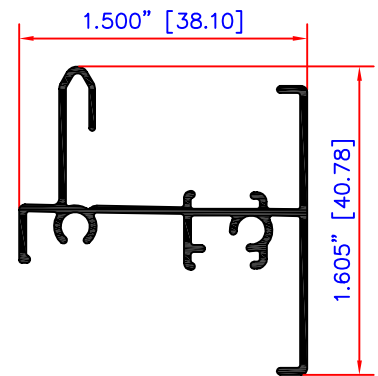

RIEL COMBINADO PARA FIJO
1518

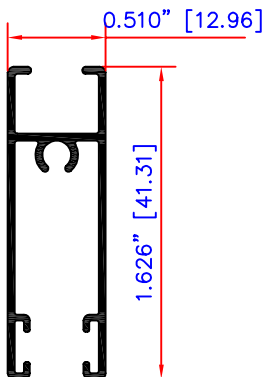

ZOCLO
1519

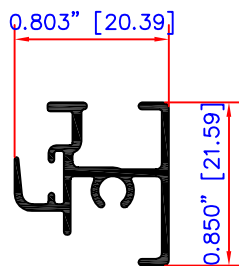

TRAVESAÑO FIJO
1505

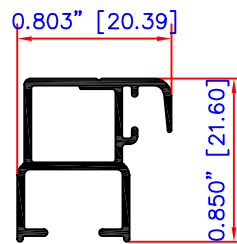

TRAVESAÑO CORREDIZO
1526

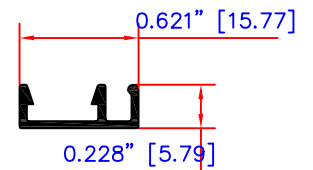

MOSQUITERO FIJO ULTRA
2058

PERFILES DE ALUMINIO	CANT.	CORTE	MEDIDA (mm)
I-1517 RIEL Y CABEZAL	2	90°	H-15
I-1522 JUNQUILLO	2	90°	$\langle H/2 \rangle - 21$
I-1521 CABEZAL	1	90°	$\langle H/2 \rangle - 48$
I-1519 ZOCLO	1	90°	$\langle H/2 \rangle - 48$
I-2058 MOSQUITERO	2	45°	$\langle H/2 \rangle - 22$
I-1516 JAMBA	2	90°	V
I-1522 JUNQUILLO	2	90°	V-47
I-1505 TRAVESANO FIJO	1	90°	V-19
I-1526 TRAVESANO CORR	1	90°	V-38
I-1524 JALADERA HOJA	1	90°	V-38
I-2058 MOSQUITERO	2	45°	V-35

HERRAJES Y ACCESORIOS	CANT.	UNID.
H-101 PIJAS	14	PZ
H-102 CARRETILLAS	2	PZ
H-103 CIERRE CENTRAL	1	PZ
H-104 VINIL	2H+4V	ML
H-105 VINIL COLA DE RATA	1H+2V	ML
H-106 FELPA	2H	ML
H-107 ESCUADRAS P/MOSQ.	4	PZ

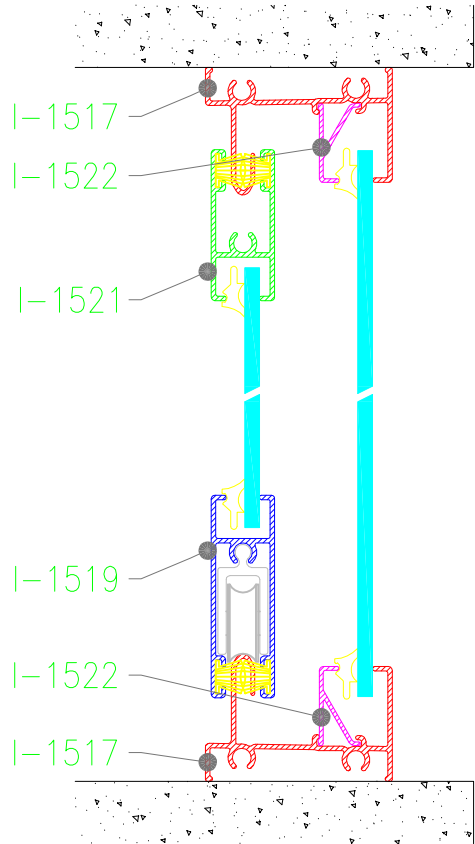

Y

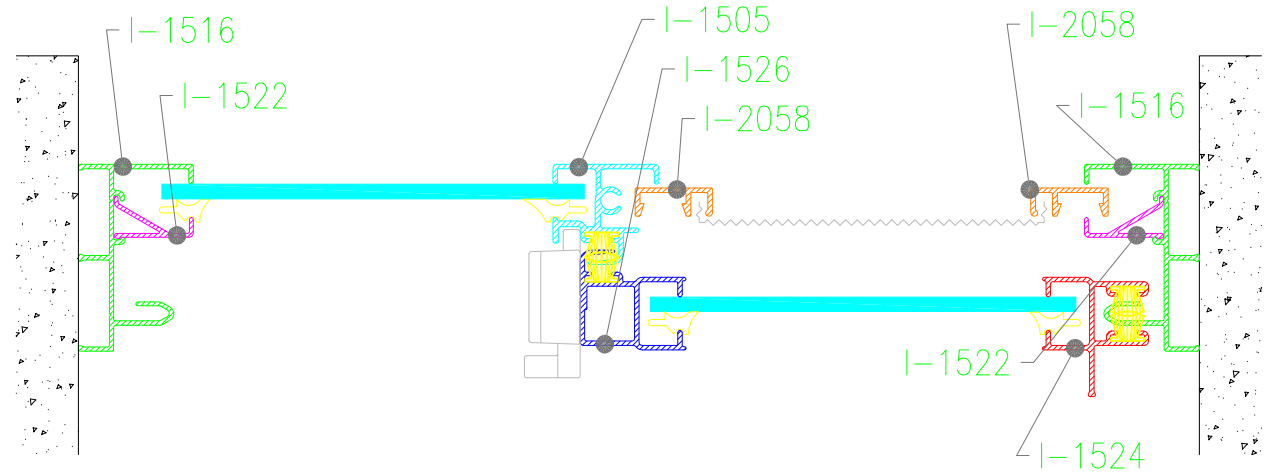
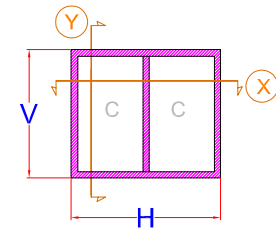

X

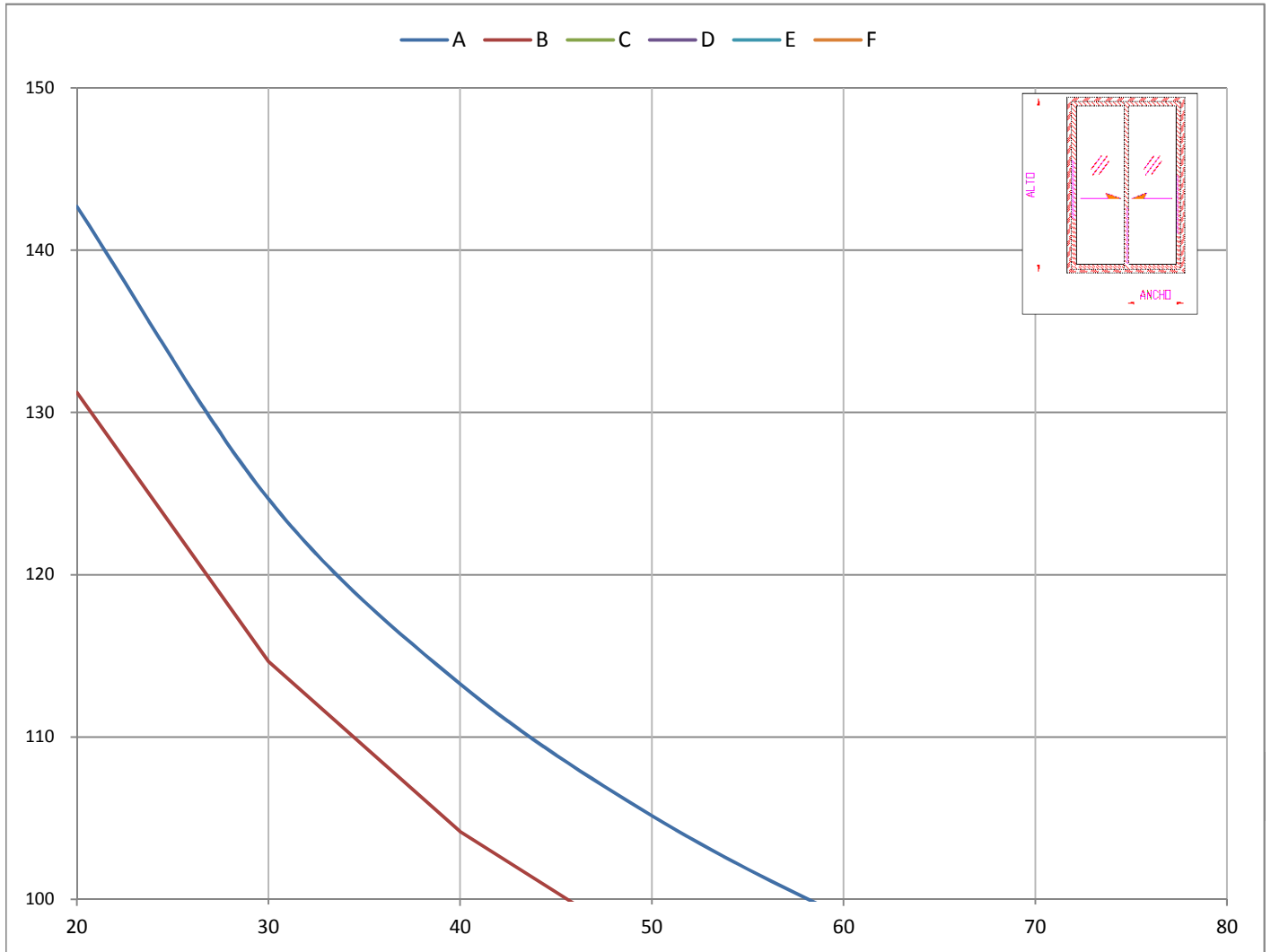

CURVA	PRESION DE DISEÑO	VELOCIDAD DE VIENTO	ZONA
A	35 Kg/m ²	70 Km/h	Centro de grandes ciudades
B	45 Kg/m ²	80 Km/h	Centro de grandes ciudades
C			
D			

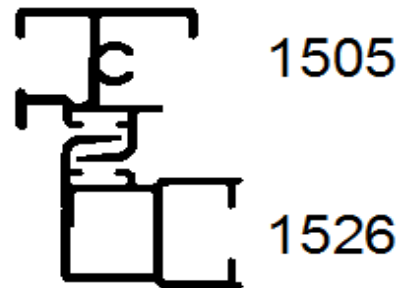

- * Los límites de fabricación para un cancel utilizando estos perfiles serán los que se encuentren debajo de las curvas graficadas
- * Los límites de un cancel van en función de la combinación de la resistencia del perfil de aluminio, el cristal y los accesorios
- * Calcular y revisar la deflexion del perfil de aluminio y su compatibilidad con el cristal utilizado
- * Este gráfico es aplicable para perfiles con Aleación 6063 Temple T5